



# De Lorean Owner's Handbook

Part No. 113090



Published by

De Lorean Motor Cars (1982) Limited

# Introduction

We would like to take the opportunity to thank you for selecting a De Lorean motor car and to wish you many years of happy and trouble free motoring.

This handbook should be considered a permanent part of the vehicle. Please read it carefully as it contains important operating, maintenance and safety information.

The first part of the book tells you how to operate the controls, switches and accessories and gives the necessary information on driving and operating your car.

Part Two gives a full summary of the maintenance required by your car. We strongly recommend that this is entrusted to your dealer who has the necessary expertise and specialised equipment.

Part Three gives details on emissions applicable to the North American Market and part Four contains useful information on emergency operating procedures.

Finally Part five is the General Information section covering vehicle specification, capacities, etc.

- Part 1 - Controls and Operating
- Part 2 - Maintenance
- Part 3 - Emissions Control System (North America)
- Part 4 - Emergency Operating Procedures
- Part 5 - General Information

## Note:

The specifications and descriptions contained in this manual were accurate at the time they were approved for printing. De Lorean Motor Cars (1982) Ltd., reserves the right to make changes at any time without notice.

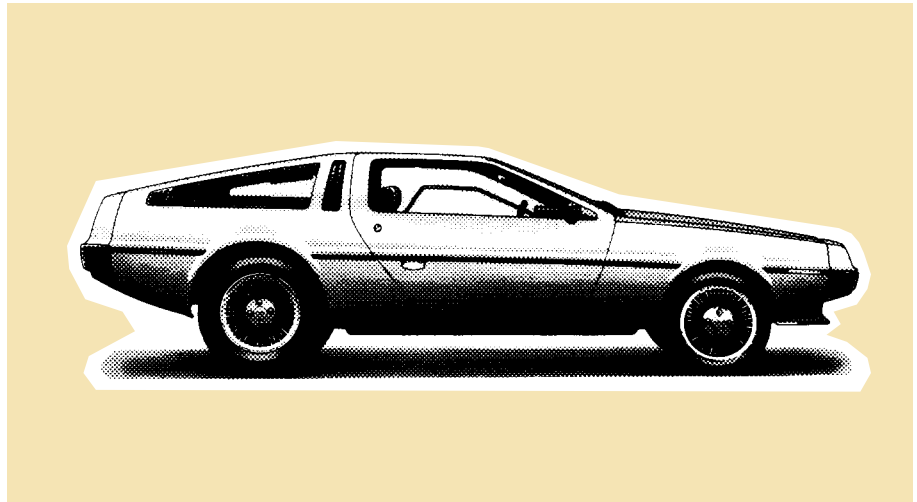

# Controls and Operating

Key to Car Controls	4 - 5	Seat Back Recline Adjustment	7	Ignition Switch and Anti-Theft	
Key to Instrument Cluster	5	Seat Back Release Lever	7	Deterrent Steering Column Lock	11
Doors and Locks	6	Parking Brake	7	Interior Lights	12
External	6	Inertia Seat Belts	8	Remote Control Side View Mirrors	12
Internal	6	Warning System	8	Interior Rear View Mirror	12
Locking Storage Compartment	6	Wearing	8	Steering Column Adjustment	12
		Care of Seat belts	8	Luggage Compartment	13
Seats	7	Steering Column Controls	9	Fuel Filler Cap	13
Seat Travel Adjustment	7	Centre Console Controls	9	Engine Compartment	13
		Centre Instrument Panel Controls	10	Driving Information	14
		Temperature Control	10	Starting	14
		Fan Speed Control	10	Selector Positions – Manual	14
		Main Selector Switch Positions	10	Automatic Transmission Operation	14
		Light Switch	11	Automatic transmission Selector	
		Hazard Warning Flasher	11	Positions	14
		Illumination Control	11	Warming Up	15
		Rear Window Defogger Indicator	11	Running In	15
		Cooling Fan Fail Indicator	11	Economical Operation	15
		Door Locks Warning Indicator	11		

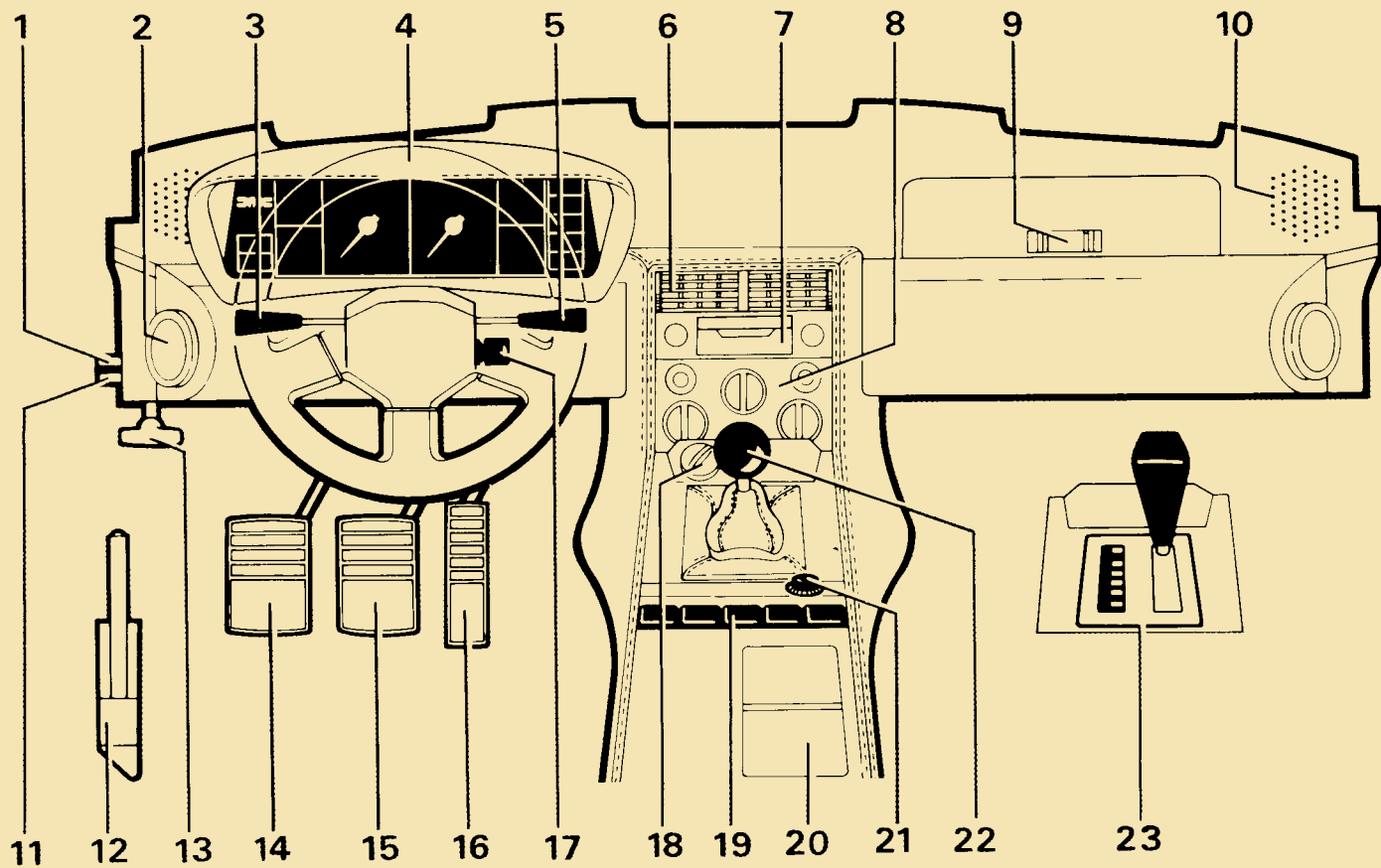

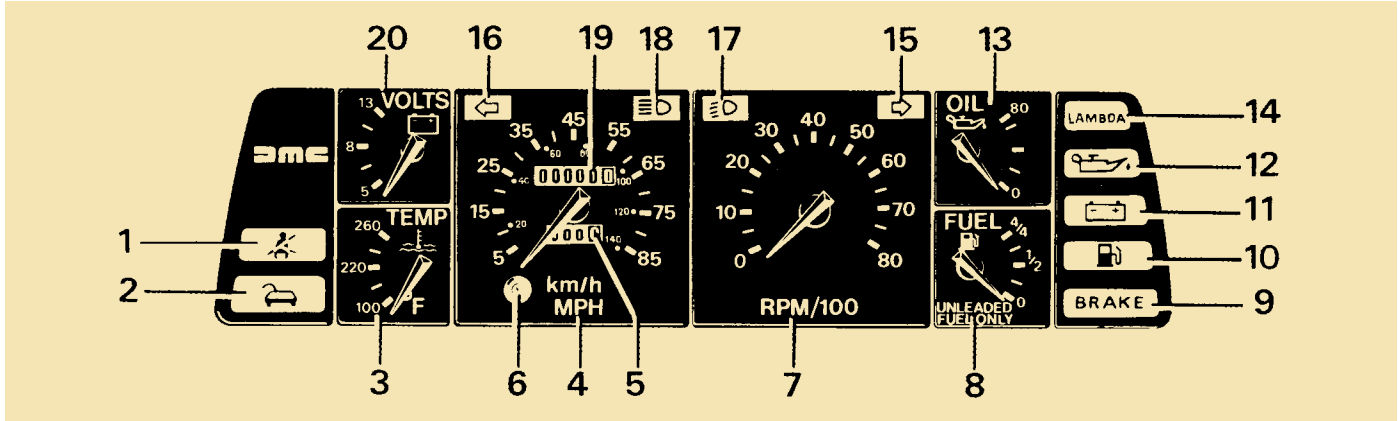

KEY TO CAR CONTROLS – Fig. 1

- |  |   |
|--|---|
| <ol style="list-style-type: none"> <li>1. Courtesy Light Switch</li> <li>2. Side Window Air Duct</li> <li>3. Left Hand Column Switch</li> <li>4. Instrument Cluster</li> <li>5. Right Hand Column Switch</li> <li>6. Face-level Air Vent</li> <li>7. Stereo Radio/Cassette</li> <li>8. Centre Instrument Panel Controls</li> <li>9. Glove Box Release</li> <li>10. Front Speaker Grille</li> <li>11. Door Ajar Warning Light Switch</li> <li>12. Parking Brake</li> <li>13. Luggage Compartment Cover Release</li> <li>14. Clutch Pedal</li> <li>15. Brake Pedal</li> <li>16. Accelerator Pedal</li> </ol> | <ol style="list-style-type: none"> <li>17. Ignition Switch</li> <li>18. Illumination Control</li> <li>19. Centre Console Controls</li> <li>20. Ashtray</li> <li>21. Cigar Lighter</li> <li>22. Gear Shift – Manual</li> <li>23. Gear Shift – Automatic</li> </ol> |
|--|---|

KEY TO INSTRUMENT CLUSTER – Fig. 2

- |  |   |
|--|---|
| <ol style="list-style-type: none"> <li>1. Seat belt Warning Light</li> <li>2. Door Ajar Warning Light</li> <li>3. Engine Temperature Gauge</li> <li>4. Speedometer</li> <li>5. Trip Meter</li> </ol> | <ol style="list-style-type: none"> <li>6. Trip Meter Reset</li> <li>7. Tachometer</li> <li>8. Fuel Gauge</li> <li>9. Brake Warning Light</li> <li>10. Low Fuel Warning Light</li> <li>11. Charging System Warning Light</li> <li>12. Engine Oil Low Pressure Warning Light</li> <li>13. Engine Oil Pressure Gauge</li> <li>14. Lambda (oxygen sensor) Service Warning Light</li> <li>15. Right Turn Indicator Light</li> <li>16. Left Turn Indicator Light</li> <li>17. Low Beam Indicator Light</li> <li>18. High Beam Indicator Light</li> <li>19. Odometer</li> <li>20. Voltmeter</li> </ol> |
|--|---|

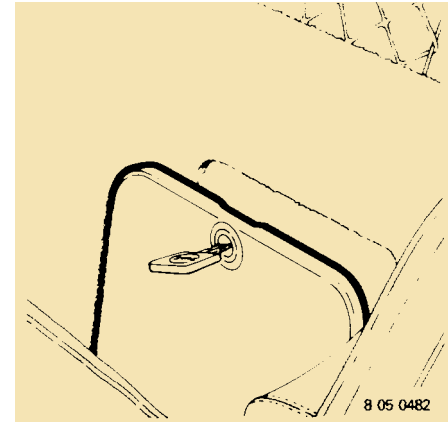
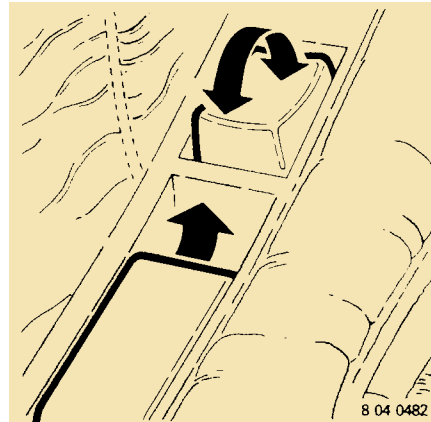
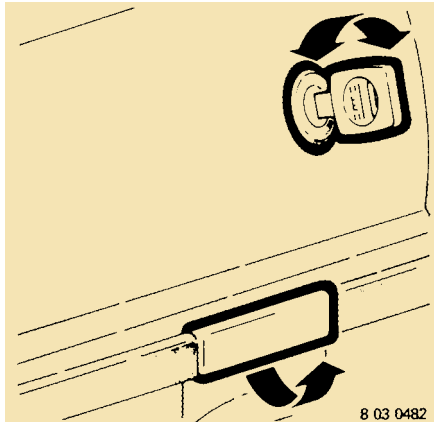

## DOORS AND LOCKS

### External – Fig. 3

The De Lorean is equipped with a central locking system which locks or unlocks both doors simultaneously. The locking or unlocking of one door will automatically lock or unlock the other.

To unlock, insert the key and turn it to the rear of the car, return it to vertical position and withdraw. Lift the external release handle and raise door to its maximum height. Due to the gull-wing design, caution should be exercised when entering or exiting the vehicle.

To close, pull the door down and continue to close the door by placing a hand on the window sill directly below the power window glass. Do not attempt to close the door by exerting pressure at the front edge as this could result in a 'sprung' door requiring adjustment and possible repair.

### Internal – Fig. 4

To unlock door from the inside press the front of the door lock switch in the armrest, lift the lever also located in the armrest and raise the door to the fully open position. To close from inside pull the door firmly downwards with the assist bar located in the lower portion of the armrest.

### Locking Storage Compartment – Fig. 5

The locking storage compartment is located behind the driver's seat.

Take care not to leave keys in the car.

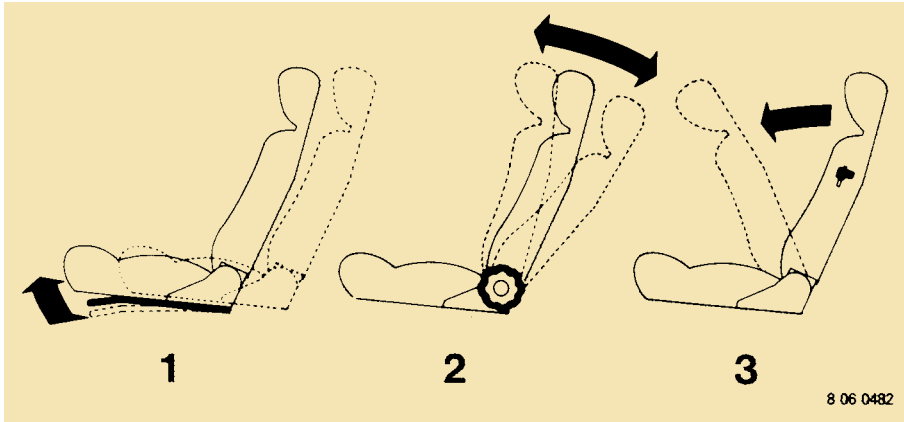

SEATS – Fig. 6

### Seat Travel Adjustment

Lift up on the seat travel release bar (1) and slide complete seat backwards or forwards. Make certain that seat is locked position after satisfactory adjustment has been made.

### Seat Back Recline Adjustment

Rotate recliner knob (2) either backwards or forwards to adjust seat back to required position.

### Seat Back Release Lever

Lift release lever (3) to allow seat back to tilt forward for access. Ensure lock is engaged when returning seat back to original position.

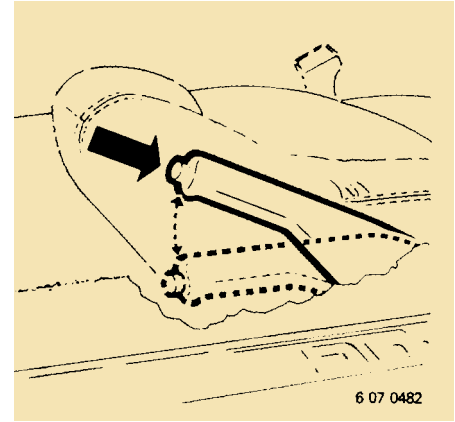

Parking Brake – Fig. 7

The parking brake, located adjacent to the driver's side door sill, is applied by pulling up the handle. To release, pull the handle upwards and press in the button at the end of the handle. Continue to hold the button in while lowering the handle.

Note: The brake warning light in the instrument cluster will illuminate when the parking brake is on.





3 08 0482

**INERTIA SEAT BELTS – Fig. 8**

**Warning System**

The seat belt warning light *Fig. 8* will glow when the ignition is switched on and either seat is occupied with the seat belt unfastened, a warning buzzer will also activate for approximately ten seconds.

**Wearing**

Always wear the seat belt as a diagonal assembly, until the lap section is comfortably tight. Check that belt is lying flat and is not twisted.

The belt is intended to be worn by occupants of adult build. Under no circumstances must it be used for more than one person, even for small children.

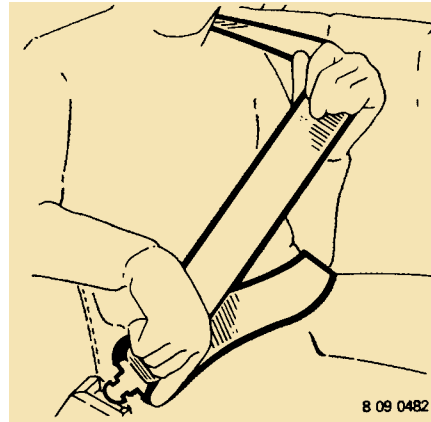

8 09 0482

Withdraw the belt from the reel with a steady pull, sudden snatches will lock the reel.

To fasten, pull the belt over the shoulder and hips, *Fig. 9* and press the tongue into the lock nearest the wearer *Fig. 10*. A click will indicate that the belt is locked.

To release, push the 'PRESS' button on the lock. Stow the belt by allowing it to retract fully, manually assisting the last few inches.

**Care of Seat Belts**

Regularly inspect the seat belt webbing for signs of abrasion or wear, giving particular attention to fixing points and adjusters.

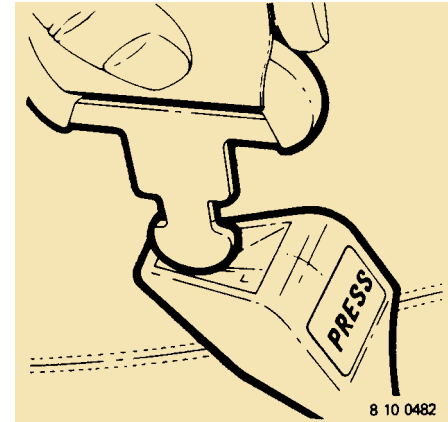

8 10 0482

Renew a seat belt assembly which is in any way damaged or which has withstood the strain of a severe impact.

Do not attempt to make any alterations or additions to the seat belts or fixings as this could impair their efficiency.

Use the seat belt at all times – even on a short journey.

Clean seat belt by sponging with warm water and non-detergent soap. Allow to dry naturally.

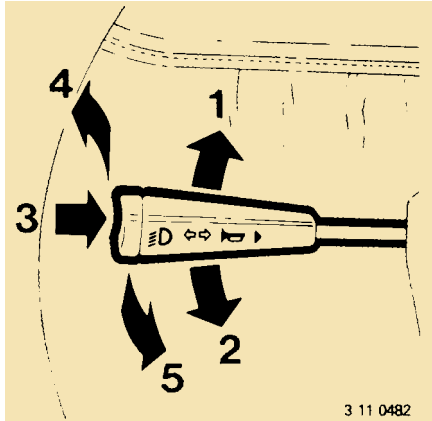

3 11 0482

## STEERING COLUMN CONTROLS – Fig. 11

- (1) Direction indicator – raise for right.
- (2) Direction indicator – lower for left.
- For (1) and (2) green indicator light in instrument panel will flash, to indicate operation and direction of signal.
- (3) Horn – press.
- (4) High beam – move lever away from central position, which is low beam position.
- (5) Headlight flasher – pull lever from central position towards steering wheel. This will activate high beam until lever is released.

Note: Blue indicator light in the instrument panel will illuminate when high beam is on.

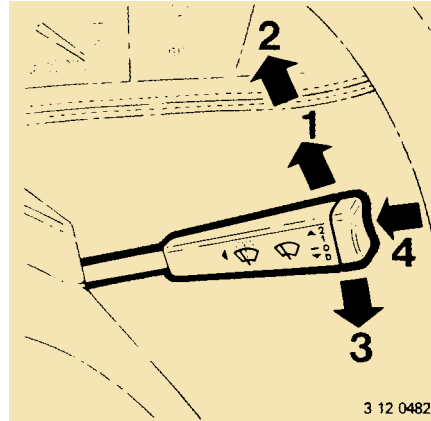

3 12 0482

## STEERING COLUMN CONTROLS – Fig. 12

- (1) Normal speed wipe.
- (2) High speed wipe.
- (3) Single and delayed wipe.
- For single wipe, press lever down momentarily. For delayed wipe press lever down for about three seconds before releasing.
- (4) Wash wipe – press lever towards steering column to operate washers and low speed wipe which will continue for approximately 5 seconds after release.

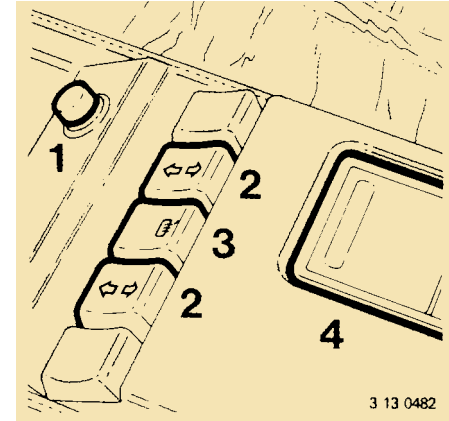

3 13 0482

## CENTRE CONSOLE CONTROLS – Fig. 13

- (1) Cigar lighter. To use push in all the way and it will release back to normal position when ready for use.
- (2) Power window switches – operate only with ignition on.
- (3) Rear defogger switch – indicator light will illuminate in centre instrument panel when switched on.
- (4) Ash tray – to empty, lift upwards and release from spring clip.

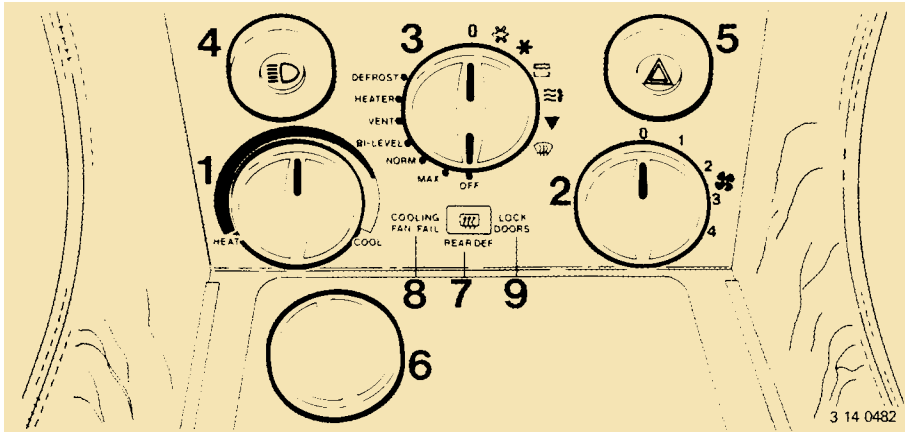

## CENTER INSTRUMENT PANEL CONTROLS – Fig. 14

### Temperature Control (1)

This knob controls the temperature of the air discharged from the vents with hotter air being provided as the knob is turned anti-clockwise. Use this control in conjunction with main selector switch (3) as operation of the temperature control is only effective in certain selector switch positions.

### Fan Speed Control (2)

This knob is used to vary speed of air flow fan. Operative only when Heater/Air conditioner selector (3) is at off.

### Main Selector Switch Positions (3)

**OFF** – Blower fan and air conditioning off. Ventilation provided to foot well, defroster and door vents.

**MAX** – This maximum air conditioning setting with temperature at full cold. Set fan speed as desired (speed 4 for maximum). Recirculated air is supplied to face level and door vents.

**NORM** – Use for refrigerated fresh air. Turn temperature and fan speed controls to desired position. Air conditioned fresh air is provided to face level and door vents.

**BI-LEVEL** – In this position and with the temperature control in mid-position, conditioned air is provided to the face level and door vents while conditioned warmer air is provided to the footwells and a lesser amount to the windscreen. Adjusting the temperature control will vary the temperature accordingly.

**VENT** – Fresh air at outside temperature is supplied to the face level and door vents with the temperature control set to full cold. Select fan speed desired.

**HEATER** – Use this setting for heated air to the footwells. Adjust temperature and fan speed as desired. A small amount of warm air will also be supplied to defroster and door vents.

**DEFROSTER** – Main air flow is to the defroster vents with a small amount only to footwells and door vents. For maximum performance turn temperature control to full hot, fan speed to position four, close vents at each door.

### Notice:

Do not continue to run the engine with temperature gauge registering an excessively high reading as engine damage may result.

When air conditioning is not in frequent use, operate it for a few minutes each week to lubricate compressor.

## Light Switch (4)

First push – Parking/side lights on.

Second push – Headlight/side lights on/

Third push – Off.

The headlight beam, high or low, is controlled by lever on left hand side of steering column (see Fig. 11, Page 9).

High beam – Move lever away from central position which is low beam position.

## Hazard Warning Flasher (5)

Push once and all front and rear directional signals will flash. Push again for off.

## Illumination Control (6)

The illumination brightness of instrument cluster and display can be controlled by rotating the control knob.

## Rear Window Defogger Indicator (7)

This indicator will illuminate when the defogger is in use. The system incorporates a timing device which automatically switches the circuit on or off in a continuous cycle of several minutes duration for optimum efficiency.

## Cooling Fan Fail Warning Indicator (8)

This indicator (RED when illuminated) is a warning that one or both of the engine electric cooling fans is not operating when required. Such a failure could cause excessively high engine temperatures. Careful observation of engine temperature gauge is necessary and dealer should be consulted immediately in the event of gauge registering an excessively high reading.

## Door Locks Warning Indicator (9)

This indicator will illuminate (RED) when doors

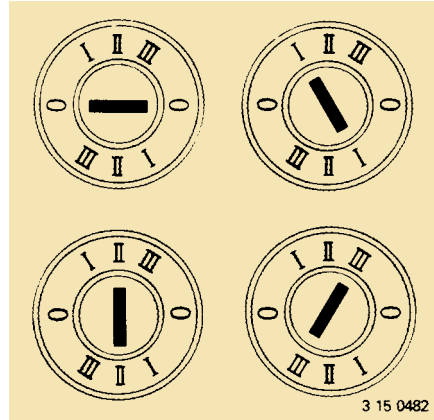

are unlocked.

## IGNITION SWITCH AND ANTI-THEFT DETERRENT STEERING COLUMN LOCK – Fig. 15

The ignition switch is located on the right hand side of the steering column assembly. The following are the operating parameters of each ignition switch position.

### 0 – Locked Position

In this position with the key removed the steering wheel will be locked and all electrical systems except interior and exterior lights, hazard warning lights, horn, lighter, stop lamps and door locks will be

inoperative.

### I – Accessory Position

In this position, all electrical systems except the instrument cluster warning lights, wipers, turn signals, gauges and engine electrical systems will operate. In this position, the steering column lock will be released.

### II – Run Position

In this position all remaining electrical systems become operational.

### III – Start Position

In this position the engine is cranked. Once the engine has started and the key is released, the switch will automatically return to position II.

Notice:

If difficulty is experienced in turning the ignition key from the lock position, turn the steering wheel from side to side while turning the ignition key towards the accessory position.

Do not apply more force to the key than you can exert with your hand alone.

**CAUTION:** Do not remove the key from ignition switch while the vehicle is in motion as steering column will lock and vehicle control will be lost.

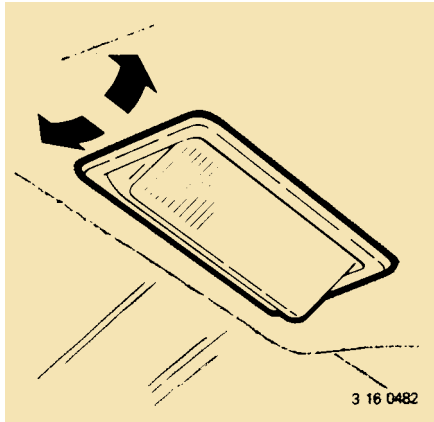

**INTERIOR LIGHTS – Fig. 16**

The two interior lights incorporate a three position switch within the lens assembly.

**Forward Switch Position:** Light operates when either door is opened. In this position a delay unit will cause the lights to remain on for approximately 10 seconds after the door is closed.

**Center Switch position:** Light will remain off regardless of door position.

**Rearward Position (as illustrated):** Light will remain on indefinitely.

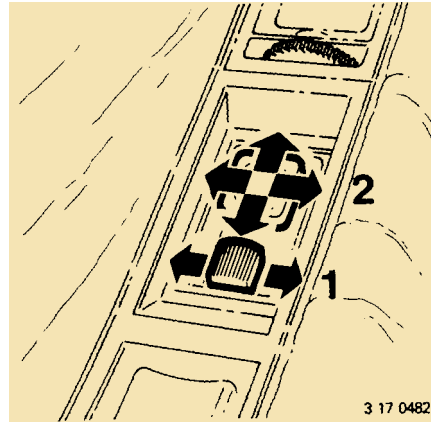

**REMOTE CONTROL SIDE VIEW MIRRORS – Fig. 17**

The control for the electrically operated side view mirrors is located in the driver's door armrest.

The sliding switch (1) is used to select left or right hand mirror.

The control switch (2) is used to adjust the mirror within its housing although the complete assembly housing can, if necessary, be manually pivoted backwards or forwards.

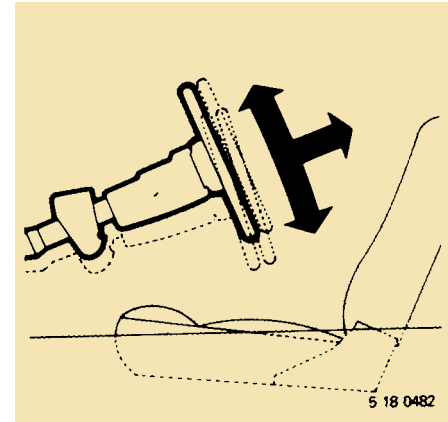

**Interior Rear View Mirror**

Adjust the mirror to give a clear view through the rear mirror. Annoying headlight glare can be avoided by moving the lever at the base of the mirror towards the windscreen.

**STEERING COLUMN ADJUSTMENT – Fig. 18**

The column may be adjusted (up and down – fore and aft) to the desired position. To adjust loosen the adjuster knob on the right hand side of the steering column, behind the low instrument panel pad.

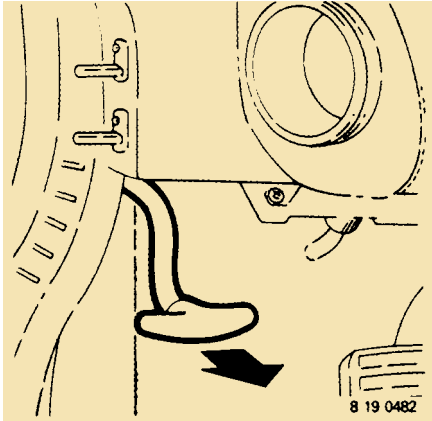

## LUGGAGE COMPARTMENT – Fig. 19

To open pull lever located on the left hand side of the driver's footwell.

Lift the compartment lid to the fully open position where it will remain supported by its gas struts.

To close, lower the compartment lid and press down firmly over catch to lock.

The luggage compartment light will automatically operate when the lid is open.

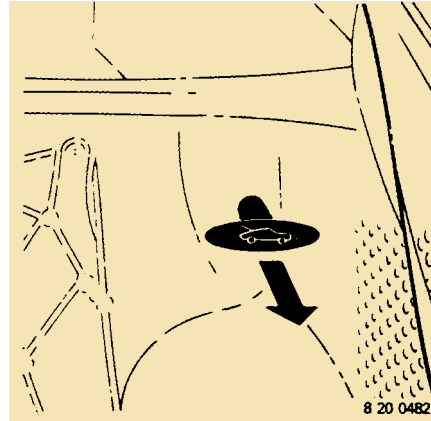

## FUEL FILLER CAP

Access to the fuel filler is gained by lifting the luggage compartment lid. The cap is located at the left rear corner of the compartment.

Do not over fill the tank in view of danger from exposed fuel.

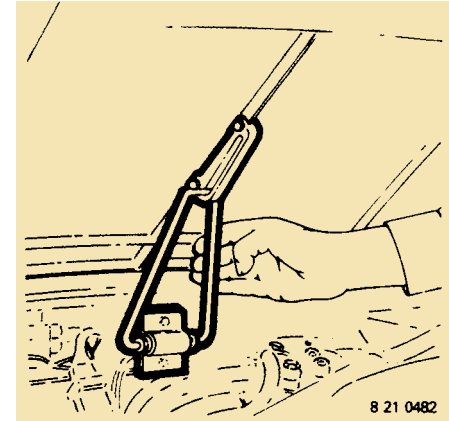

## ENGINE COMPARTMENT – Figs. 20-21

To Open – Pull release handle located on bulk head behind driver's seat. Raise louvre by lifting centre catch lever on underside of rear panel edge. The gas filled struts will support the louvre. Raise engine compartment lid to fully open position where it will be held by the engine cover support.

To Close – Raise the engine compartment lid sufficient to release it from the cover support. Lower gently and press firmly into catch to secure.

Finally lower louvre and press firmly into catch to secure.

## DRIVING INFORMATION

### Starting

Check that the gear lever is in neutral position (manual gearbox) or in 'P' or 'N' (automatic gearbox).

Check that the handbrake is on.

Press accelerator pedal down approximately one quarter of its travel.

Insert ignition key and turn to starting position (III) and as soon as engine starts release key and accelerator pedal.

The red ignition and oil pressure warning lights will go out when engine is running.

Note: one automatic gearbox cars the starter will only operate with the gear lever in 'P' or 'N' position.

Do not operate the starter for longer than 5 or 6 seconds. If the engine does not start wait until the engine has stopped rotating before trying to restart.

### Selector Positions – Manual – Fig. 22

Moving the gears to the positions shown select the appropriate gear ratio. The lever is spring biased toward the third – fourth position therefore, selection of first, second, fifth and reverse is made by moving the gear lever against spring pressure.

To select reverse, it is necessary to LIFT UP on the gear lever knob whilst moving lever to its position.

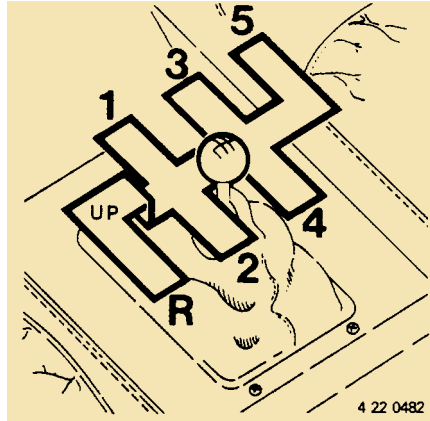

### AUTOMATIC TRANSMISSION OPERATION

Do not use the 'P' position in place of the parking brake. Always set the parking brake, shift in 'P' and turn off the ignition when you leave the vehicle unattended.

For smooth operation, depress the brake pedal when shifting from NEUTRAL or PARK to REVERSE or a forward gear.

### Notice:

Shift into 'R' and 'P' only when the vehicle has come to a complete stop.

When stopped on an upgrade do not hold vehicle with engine, use brake.

Do not shift from 'N' or 'P' into any gear selection when the engine is above idle speed.

Lift the button located under the front of the selector lever when engaging 'R' and 'P'.

### Automatic Transmission Selector Positions – Fig. 23

Engine Starting – use the 'P' position.

P (Park)

Use only when the vehicle is stopped.

R (Reverse)

For backing vehicle – from stop.

N (Neutral)

For standing (brakes applied).

D (Drive)

This is the normal driving position, and the transmission will automatically shift through a three gear sequence, giving economy and power. For extra power when passing another vehicle or climbing steep grades, depress the accelerator pedal fully to the floor, at which time the transmission will down shift into a lower gear.

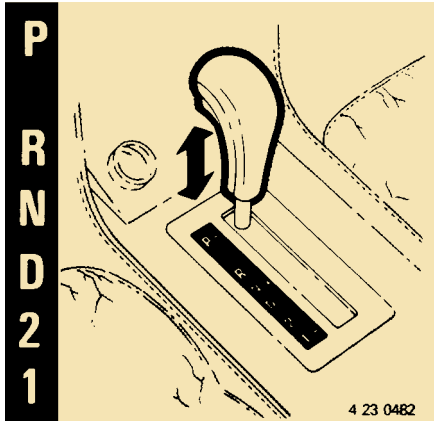

## 2 (Second Gear)

Manually shift the gear selector to this position for driving in heavy, slow-moving traffic, for more power when climbing hills, for braking assist when going down hills, or for starting on slick surfaces and other situations where gentle acceleration may allow the automatic operation of first and second gear including a throttle activated 2 – 1 down shift.

## 1 (Low Gear)

Shift the selector to low gear for maximum power in hard-pulling situations, or for climbing and descending very steep grades. This selection will allow first gear operation only. Do not exceed 45 mph in the '1'

position.

Moving up a steep grade from a standing start:

Depress the brake pedal with your left foot, shift the selector level to 'D' or '1' depending on the load weight and steepness of the grade, and release the parking brake. Depress the accelerator pedal gradually with your right foot, while simultaneously releasing the foot brake.

### Warming Up

When the engine is cold, drive the car as soon as the engine has started, Do not warm up the car by allowing it to idle for long periods with the car stationary.

### Running In

During the first 500 miles or 800 km:

DO NOT exceed 50 mph (80 km/h).

DO NOT operate at full throttle in any gear.

DO NOT allow the engine to labour in any gear.

### Economical Operation

To achieve the best possible degree of fuel economy it is essential, as a first priority, to ensure that the vehicle is maintained to its optimum level of performance in accordance with Manufacturers' recommendations.

Apart from regular maintenance there are a number of areas where deliberate and conscious actions on the part of the owner can achieve quite marked improvements.

The following are recommended:

- Accelerate gently through the gears.
- Switch off engine if vehicle is expected to be stationary for more than half a minute
- Avoid short stop-start journeys.
- Anticipate obstructions, junctions and sharp bends and adjust speed as necessary.
- Do not generate unnecessary speed.
- Decelerate gently and avoid braking heavy where possible.
- Stay in top gear as long as possible at the lowest realistic engine speed – but without labouring the engine.
- Ensure tyres are correctly inflated.
- Remove ski-rack or any other unnecessary weight or obstructions
- Use air conditioning only when necessary.



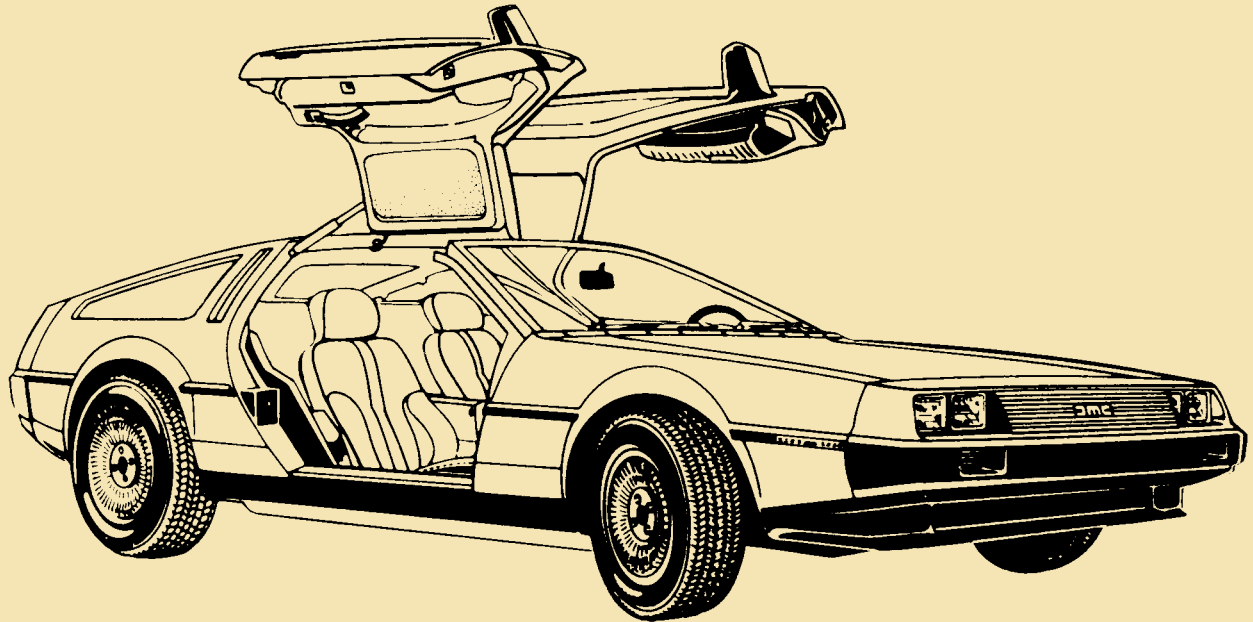

# Maintenance

Maintenance	18	Weekly Maintenance	18	Maintenance Operations	22
Appearance Care	18	Maintenance Schedule	19	Checking Engine Coolant Level	22
Windshield	18	Lubrication	20	Checking Brake Fluid Levels	22
Wheels	18	Engine/Emissions Maintenance	20	Checking Clutch Fluid Level	23
Roof Lining (Interior)	18	Transmission, Brakes, Steering and		Checking Windshield Washer	
Leather Upholstery	18	Suspension	20	Fluid Level	23
Stainless Steel Panels and		Wheels and Tyres	21	Checking Battery	24
Exterior Trim	18	Electrical	21	Checking Belt Tension and Condition	24
		Body	21	Checking Engine Oil Level	24
				Checking Automatic Transmission	
				Fluid Level	24
				Recommended Lubricants	25
				Checking Tyre Inflation Pressure	25
				Fuse Replacement	26
				Fuses	27 – 29
				Lamp Specifications	30
				Spare Wheel	30

## MAINTENANCE

The following pages contain details of both periodic routine maintenance which is best entrusted to your DMC dealer, together with weekly maintenance which may be undertaken by the owner or his service station. For the more enthusiastic and capable owner, we have provided additional information to help him should he wish to undertake some of the more basic operations personally.

Note: In extreme climatic operating conditions such as severe cold or extreme heat and dust, more regular maintenance will probably be necessary.

Please consult your DMC dealer who will give full guidance.

## APPEARANCE CARE

### Windshield

When washing the windshield, hinge the wiper blade (spring loaded against glass) away from the windshield. Wash the wiper blade with clean water.

The windshield wiper is hinged so that it may be lifted clear of the glass when cleaning the windshield. Never push the blade across the windshield, this will damage the linkage mechanism.

### Wheels

Using a brush with nylon or natural bristles only, the wheels should be washed with warm water and detergent.

### Roof Lining (Interior)

Normal cleaning consists of lightly wiping the interior roof lining with a cloth dampened in a mild soap and water solution; it is important that the cloth is only dampened not soaked.

### Leather Upholstery

The leather should first be wiped with a cloth dampened in warm soapy water followed with a second wiping using a fresh cloth and water only. Avoid flooding or soaking the leather. Finish by drying and polishing with a soft dry cloth.

It is important to use a mild non-caustic soap (or soap flakes).

An occasional use of leather treatment is recommended after the leather has been in use for a year or two.

## Stainless Steel Panels and Exterior Trim

Washing – Wash panels with warm water and low suds detergent. Stains of tar or grease may be removed with gasoline or white mineral spirits.

Polishing – The car should be washed before applying the polish treatment suggested by your DMC dealer, to preserve the appearance of the stainless steel panels.

## WEEKLY MAINTENANCE

- Check/top up engine oil.
- Check/top up brake fluid reservoir.
- Check/top up cooling system.
- Check/top up washer reservoir.
- Check types for tread depth, visually for extreme cuts, lumps or bulges.
- Check/adjust tyre pressures including spare.
- Check tightness of wheel fastenings.

SERVICE CODE LETTER		THE PERIOD BETWEEN SERVICES SHOULD NOT EXCEED 12 MONTHS									
A	MILES KM	1000 1600									
B	MILES KM		7500 12000		22500 36000		37500 60000		52500 84000		67500 108000
C	MILES KM			15000 24000			45000 72000		60000 96000		
D	MILES KM					3000 48000					75000 120000

Regular maintenance together with the use of genuine DMC parts is the key to economy, safety, and reliability for your car.

It is in your interest to have your car maintained regularly by your DMC dealer who has qualified personnel and the required facilities.

Operation Description		Service			
		A	B	C	D
LUBRICATION	Renew engine oil and filter . . . . .	X	X	X	X
	Check/top up brake fluid reservoir . . . . .	X	X	X	X
	Drain and refill manual transmission and final oil drive . . . . .	X	X	X	X
	Drain and refill auto transmission fluid . . . . .	X		X	X
	Check and top up auto transmission fluid . . . . .		X		
	Check and top up cooling system . . . . .	X	X		
	Drain and renew coolant . . . . .			X	X
	Grease balljoints . . . . .		X	X	X
	Check and top up clutch fluid . . . . .	X	X	X	X
	Lubricate and latches and hinges . . . . .	X	X	X	X
Lubricate accelerator control linkage and pedal pivot . . . . .	X	X	X	X	
ENGINE/EMISSIONS MAINTENANCE	Check and adjust drive belts . . . . .	X	X	X	X
	Check and adjust ignition timing . . . . .	X			
	Renew spark plugs . . . . .			X	X*
	Renew air cleaner element . . . . .		X	X	X*
	Check valve clearance . . . . .				X
	Check tightness of intake and exhaust manifolds . . . . .	X			
	Check fuel system for leaks, pipes and unions for chafing . . . . .	X	X	X	X
	Check exhaust system for leaks and security . . . . .	X	X	X	X
Renew oxygen sensor . . . . .				Every 30,000 miles	
<i>* NORTH AMERICA ONLY</i>					
TRANSMISSION, BRAKES, STEERING AND SUSPENSION	Check condition and security of steering joints and gaiters . . . . .	X	X	X	X
	Inspect brake pads for wear and discs for condition . . . . .		X	X	X
	Check brake servo hoses for security and condition . . . . .		X	X	X
	Check/adjust wheel alignment . . . . .	X	X	X	X
	Check visually brake and clutch hydraulic pipes and unions for cracks, chafing, leaks and corrosion . . . . .	X	X	X	X
	Inspect free play of wheel bearings front and rear . . . . .			X	X
Inspect front and rear suspension and steering for damage and security . . . . .	X	X	X	X	

	Operation Description	Service			
WHEELS AND TYRES	Check tyres for tread depth and visually for external cuts in fabric, exposure of ply or cord structure, lumps or bulges . . . . .	X	X	X	X
	Check tyres comply with manufacturers' specification . . . . .	X	X	X	X
	Check/adjust tyre pressures, including spare wheel . . . . .	X	X	X	X*
	Check tightness of wheel nuts . . . . .	X	X	X	X*
ELECTRICAL	Check operation of original equipment, i.e. horns, wipers, exterior lights, windshield wash/wiper, turn signals, warning lights, instruments interior lights, electric door locks, electric door mirrors, etc . . . . .	X	X	X	X
	Check and adjust windshield washers and top up reservoir . . . . .	X	X	X	X
	Check and adjust head lamp alignment . . . . .	X	X	X	X
	Check wiper arms and blades – renew if necessary . . . . .	X	X	X	X
BODY	Check condition, security and operation of seat belts . . . . .	X	X	X	X
	Check operation of doors, hood and engine compartment locks. . . . .	X	X	X	X

  

Note:

- Replace brake fluid every 15,000 miles
- Replace brake servo filter
- Replace flexible brake hoses
- Recondition brake caliper and master cylinder seals

}

Every 45,000 miles  
or 72,000 kms

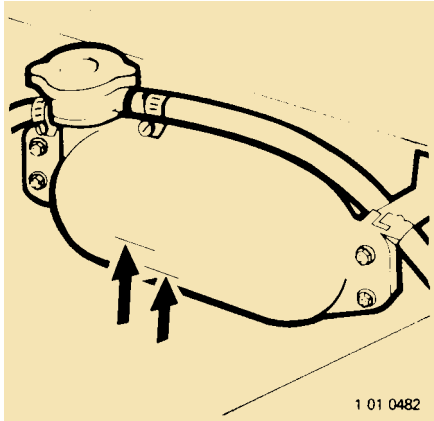

1 01 0482

## MAINTENANCE OPERATIONS

### Checking Engine Coolant Level – Fig. 1

The cooling system is a high-pressure type with see through coolant reservoir and is filled with year-round coolant at the factory.

The coolant mixture is comprised of 50% demineralized water and 50% ethylene glycol base for aluminum engine protection, as well as anti-corrosive and anti-freezing additives.

For recommended service periods consult the Service Maintenance Schedule.

### Notice:

- Do not use anti-freezes with any borax additives as this chemically attack the aluminum and cause severe engine damage.
- Do not use alcohol or methanol base coolants.
- Have your anti-freeze protection checked at the beginning of the winter season and/or before traveling to a colder climate.
- Do not overfill. If frequent additions are required, see your dealer for a cooling system check.
- For any additional information regarding anti-freeze recommendations, consult with an authorized De Lorean dealer.

The coolant level should be between the 'FULL' and 'LOW' marks on the coolant reservoir when the engine is cool *Fig. 1*. If the level is near or at the 'LOW' mark, add equal parts of ethylene glycol anti-freeze and water, to bring the level to the 'FULL' mark.

**CAUTION:** Do not attempt to remove the coolant reservoir cap under any circumstances while the engine is operating. To do so could damage the cooling system and the engine and could result in serious

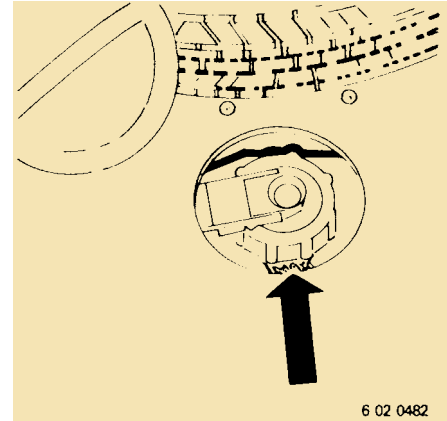

6 02 0482

personal injury from scalding coolant or steam.

Switch off engine and wait until it has cooled. Even then use extreme care when removing the cap from the expansion tank. Wrap a tick cloth around the cap and turn it slowly to the first stop.

Step back while the pressure is released from the cooling system. When you are sure all the pressure has been released, press down on the cap with a cloth, turn and remove it.

### Checking Brake Fluid Levels – Fig. 2

Unclip the right hand side of the luggage compartment carpet and pull out the rubber

With the car on a level surface, and without disturbing the filler cap, check that the level of fluid is at or just below the 'MAX' mark moulded on the translucent reservoir body. If the level is not apparent, wipe the reservoir top and cap and around the luggage compartment access hole to remove all dust and dirt. Unscrew the cap and lay aside on a clean newspaper. Beware of brake fluid dripping from the cap on removal, as this could have a detrimental effect on the surface finish. Ensure that no dirt, water or foreign matter enters the reservoir while the cap is removed.

If the level of fluid is more than 25 mm (1 in) below the bottom of the filler neck, or if the level of fluid has dropped rapidly over a short period, it is possible that fluid has been lost from a malfunction, and likely that air has entered the hydraulic system at the master cylinder. The car should not be driven until the malfunction has been investigated and corrected.

The level of fluid will drop slightly, however, as the brake pads wear. If the reservoir requires topping up, use DOT 4 hydraulic brake fluid to bring the level of fluid up to the 'MAX' mark, and replace the filler cap, tightening securely.

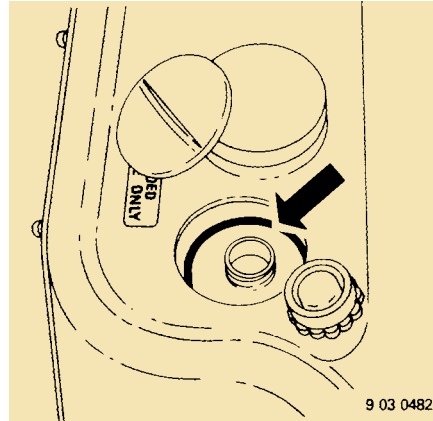

### Checking Clutch Fluid Level – Fig. 3

The clutch fluid reservoir is located on the front bulkhead next to the fuel filler neck. For access raise the front luggage compartment lid and pull out the large grommet adjacent to the fuel filler cap *Fig 3*.

Wipe around the top of the reservoir and cap and surrounding body to remove dust and dirt before unscrewing cap. Ensure that no dirt, water, or foreign matter enters the reservoir while the cap is removed.

If necessary, top up the reservoir with DOT 4 hydraulic fluid to bring the level to within 10 mm of the bottom of the filler neck. Replace the reservoir cap and access grommet.

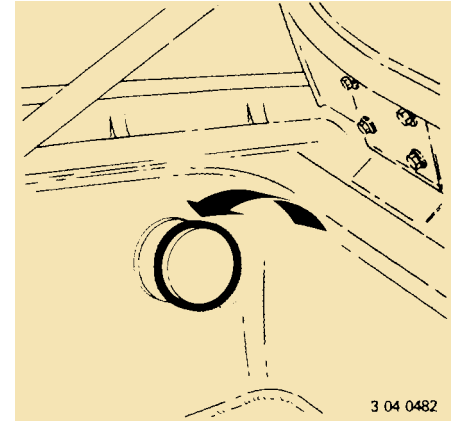

### Checking Windshield Washer Fluid Level – Fig. 4

The windshield washer reservoir is located within the body double skin at the left hand front corner of the front luggage compartment *Fig. 4*. The reservoir should be kept topped up with clean water and a proprietary windshield washer additive (or diluted methanol) to improve cleaning of the glass and remove grease, etc.

#### Notice:

Do not use radiator anti-freeze, oil, gasoline for any oil based material in the washer reservoir.



## Checking Battery

Your car has a Delco FREEDOM battery. It needs no periodic maintenance. Its top is permanently sealed (except for two small vent holes) and has no filler caps. You will never need to add water. The hydrometer (test indicator) in the top of the battery provides information for testing purposes only.

For full power needs a Delco FREEDOM battery with the same catalogue number as shown on the original battery's label is recommended, at replacement time.

**CAUTION: FOLLOW THE PRECAUTIONS LISTED IN THE JUMP STARTING CAUTION WHEN WORKING ON OR NEAR A BATTERY, PERSONAL INJURY (PARTICULARLY TO EYES) OR PROPERTY DAMAGE MAY RESULT FROM BATTERY EXPLOSION, BATTERY ACID OR ELECTRICAL (SHORT CIRCUIT) BURNS.**

## Checking Belt Tension and Condition

If a belt is worn, cracked or frayed, have it replaced. To check belt tension, apply moderate thumb pressure (approximately 22 lbs (10 kg) ) midway between pulleys and check the deflection on the longest run of the belt.

Belt	Deflection
Alternator drive belt	6-10 mm (¼ - ⅜ in)
Air conditioning compressor	6-10 mm (¼ - ⅜ in)

Note: If a belt is replaced, readjust the tension after approximately 2,000 miles (3,000 km) of driving.

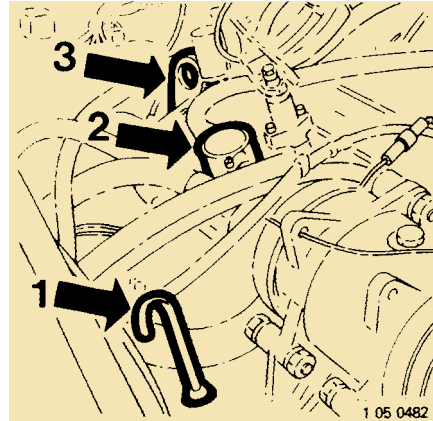

## Checking Engine Oil Level – Fig. 5

1. Be sure the vehicle is on level ground.
2. Turn off the engine and wait five minutes.
3. Pull out the dipstick (1) wipe it clean and re-insert fully.
4. Pull the dipstick out again and note reading. If the level falls on the knurled section, it is okay. If the level is near the bottom of the knurled section, add oil to bring to proper level. If 'topping up' is required, pull off the crankcase breather cap on the left valve cover (2) and add the recommended lubricant. DO NOT overfill. Replace breather cap securely.

**CAUTION:** Engine oil may be hot. Caution should be exercised to avoid the possibility of burns.

## Checking Automatic Transmission Fluid Level – Fig. 5

1. Park the vehicle on level ground and set the parking brake firmly.
2. Run the engine at idle speed until cooling fans begin to cycle – A/C off.
3. Move the selector lever through all of the gear positions and set it to the 'P' (PARK) position (engine running).
4. Wipe any dirt from the dipstick cap (3) pull out the dipstick, wipe clean and reinsert fully.
5. Pull out again, and check the level. The level should be maintained between the marked L and F on the dipstick.
6. If the level is near or at the L line, add fluid through the filler tube. DO NOT OVERFILL.

## Recommended Lubricants

Item	Classification
Engine	
Above 20°C (64°F)	Multigrade oil, service SF classification SAE 20W/50
-20°C to +40°C (2°F to 102°F)	SAE 10W/20, 10W/30, 10W/40, 15W/50, 20W/40
Below -20°C to -30°C (-2°F to -21°F)	SAE 5W/20, SW/30 This oil should not be used when temperature is continuously above 0°C.
Manual Transmission (includes final drive)	
Final Drive (automatic transmission)	
To meet spec. MIL-L-2105C or API 1 GL5	
Below -10°C (-3°F)	SAE 75
Above -10°C (-3°F)	SAE 80
Automatic Transmission	ATF type Dextron 11
Steering Gear Box Oil	API service GL-5 (SAE - EP90)
Wheel Bearing Grease	NLGI No. 2 (Lithium Base) Multi Purpose Grease
Brake and Clutch Fluid	DOT 4
Cooling System Anti-Freeze	Ethylene Glycol based (containing no Borax) with suitable corrosion inhibitors

## Checking Tyre Inflation Pressure

Tyre pressures should be checked when the tyres are cold (including the spare).

It is important that correct pressures be maintained for the best economy, ride, handling and tyre wear.

Refer to tyre pressure chart located in glove compartment.

**CAUTION:** Over or under inflated tyres can reduce tyre life, adversely affect vehicle handling and possibly lead to sudden failure which could result in loss of vehicle control without warning.

**CAUTION:** It is normal for warm tyres to exceed the recommended cold pressure, do not let air out of warm tyres to adjust pressure.

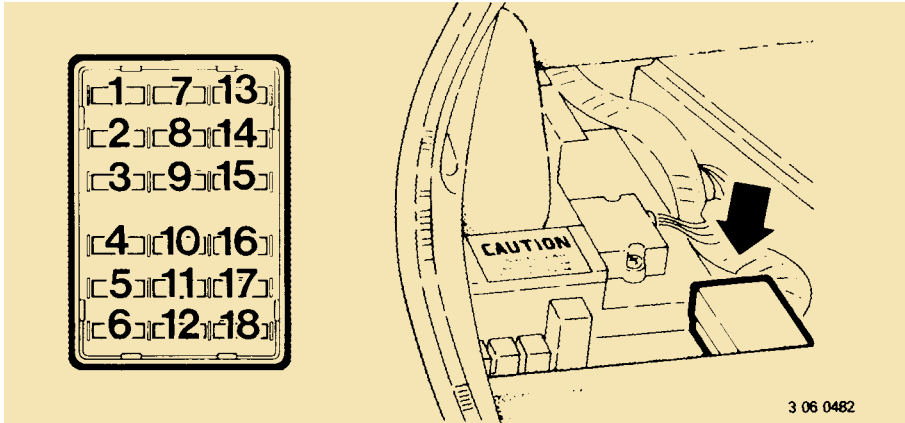

## Fuse Replacement

The fuse block is located under behind the passenger seat under the rear trim panel  
*Fig. 6.*

The circuit each fuse protects is indicated on the cover. The De Lorean uses blade fuses in place of glass cartridge fuses. The amperage rating of each blade fuse is stamped on top of the fuse body.

**CAUTION:** When replacing a blown fuse, it is important to replace it with a fuse having the correct amperage rating. Any deviation from this practice may result in a dangerous electrical overload. If a properly rated fuse continues to blow, it indicates a problem in the circuit that needs immediate correction.

The following table lists each fuse by number on the fuse box cover, the circuit(s) protected by a particular fuse, the component from which it obtains its source of operating current and amperage rating of the particular fuse.

Fuse No.	Circuit Protected	Supply	Amperage
1	Warm up regulator Ignition control unit Idle speed regulator	From ign. II	10A
2	LH Tail light LH Rear side marker LH License plate LH Front side marker LH Front park light	Only supplied when light switch operated	10A
3	Windshield wiper Windshield washer	From ign. II	10A
4	Direction indicators Turn signal lamps Stop light switch	From ign. II	20A
5	Lambda service counter Seat belt warning light Door ajar warning light Temp. gauge Oil pressure gauge Fuel gauge Oil, Battery Fuel, brake warning lights Voltmeter Tachometer Radiator cooling fans control	From ign. II	10A

Fuse No.	Circuit Protected	Supply	Amperage
6	Horns Headlamp flash switching Buzzer logic box Hazard warning lamps	Permanently live	20A
7	Lambda control unit Fuel pump	Permanently live	20A
8	Cigar lighter illumination RH License plate RH Tail lamp RH Rear side marker RH Front park light RH Front side marker Instrument illumination Clock dimmer	Only supplied when light switch operated	
9	Heated rear window Door mirrors	From ign. I	10A
10	Lock doors warning light Fan speeds 1 and 2 Fan speeds 3 and 4 Air conditioning compressor	From ign. I	20A
11	Gear illumination (auto) Door windows Air cond. panel illumination Radio display Clock illumination	From ign. I	30A

Fuse No.	Circuit Protected	Supply	Amperage
12	Door lamps Rear interior lamp Front interior lamp Glove box lamp Luggage compartment lamp Engine compartment lamp Engine diagnostics	Permanently live	10A
13	Automatic transmission	From ign. I	10A
14	Low beam	Supplied when low beam is switched	20A
15	High beam	Supplied when high beam is switched	20A
16	Reverse lamps	From ign. I	10A
17	Cigar lighter Clock supply Radio supply	Permanently live	20A
18	Stop lamps	Permanently live	20A

## Lamp Specifications

Usage	Quantity	Wattage	} Non Federal – Service unit may require separate bulbs
External Lights			
Headlights – outer*	2	Sealed Beam	}
– inner*	2	Sealed Beam	
Front turn/parking light*	2	21/5	
Side marker lights – front and rear	4	5	
Tail lights	2	5	
Brake lights	4	21	
Rear turn lights	2	21	
Back-up lights	2	21	
License plate lights	2	10	
Internal Lights			
Luggage compartment light	1	10	
Engine compartment light	1	10	
Door lights	6	5	
Interior lights	2	10	

\* DOUBLE FILAMENT

## Notice:

Because this tyre is smaller than the standard tyre, car ground clearance is reduced about 1.25 inches (30 millimeters).

To conserve tyre tread life return the spare to the storage area as soon as the standard tyre can be repaired or replaced.

Because the compact spare was specifically designed for your car, it should not be used on any other vehicle.

The compact spare tyre should not be used with any other wheel, nor should standard tyres, snow tyres, wheel covers, or trim rings be used with the compact spare wheel. If such use is attempted, damage to these items or other car components may occur.

Do not use chains with your compact spare tyre. Because of the smaller tyre size, a tyre chain will not fit properly. This could cause damage to the car and could result in the loss of the chain.

## Spare Wheel

The compact spare is designed to save space and its lighter weight makes it easier to install if a flat tyre occurs.

If a flat tyre occurs, follow the jacking instructions in this manual while keeping these points in mind:

- Check the inflation pressure as soon as practical after installing the spare (use of a pocket-type high pressure inflation gauge is advised) and adjust the pressure to 60 PSI while the tyre is stored.

- Do not drive at continuous speeds over 50 MPH (80 km/h) when compact spare tyre is installed.
- The spare wheel supplied with this vehicle is for EMERGENCY USE ONLY and should be replaced with the road wheel and tyre assembly as soon as possible. When the spare tyre is in use the handling characteristics of the vehicle will be modified.
- Less than moderate speeds and cornering loads should be observed.

# Emissions Control System (North America)

Emission Control System (North America)	32
Oxygen (Lambda Sensor Closed Loop System)	32
Emission Performance at Altitude	32



Federal and state laws establish the levels of exhaust emissions that may be emitted into the atmosphere by automobiles. To comply with these regulations, it is essential that your De Lorean be inspected and maintained in accordance with the scheduled maintenance. (See Maintenance Schedule Folder).

To control these emissions the De Lorean uses the following components:

1. Bosch K-Jetronic continuous injection, fuel injection system.
2. Oxygen (Lambda) sensor closed loop system.
3. Three-way catalytic converter.

**Notice:**

Unleaded gasoline is used to reduce combustion chamber deposits, and to prevent lead contamination of the catalytic converter.

If lead fuel is used the catalytic converter will lose emission control effectiveness.

**Notice:**

Damage to the catalytic converter can be caused if the engine is not performing correctly. Do not continue to drive your vehicle if you detect engine misfire, noticeable loss of performance or other unusual operation conditions.

**CAUTION:** Do not park your vehicle over combustible materials, such as grass or leaves. They could touch the exhaust system

and ignite.

**Oxygen (Lambda Sensor Closed Loop System)**

The Oxygen Sensor Closed Loop System monitors the exhaust as it leaves the engine and before it enters the catalytic converter. The oxygen sensor signals the electronic control unit to adjust the volume of fuel being injected into the combustion chamber.

**Notice:**

The Lambda Service Warning Light will illuminate at 30,000 miles (50,000 km) replaced with a new sensor. Such replacement is necessary in order to maintain the correct operation of the emission control system. The indicator must be reset as part of the service.

**Emission Performance at Altitude**

To ensure compliance with the Emission Regulations at high altitude and maintain optimum fuel economy and driveability your vehicle requires adjustment to the engine settings. A Service Bulletin has been supplied to your Dealer to enable him to adjust the engine correctly. Your new vehicle delivered in a high altitude area will have been adjusted prior to delivery, and a label to this effect will be attached to the engine settings label in the engine compartment. If you have permanently relocated to a high altitude area from a low altitude area or vice versa your vehicle will require adjustment to be made to achieve the

exhaust emission control, fuel economy, and driveability of vehicles originally sold at this altitude. It is recommended that you take your De Lorean to your local Dealer and have these adjustments made.

**Note:** It is not necessary to perform these adjustments if you have intend to make only a temporary visit to a high altitude location. Vehicle performance will remain adequate for any such temporary period.

**Notice:**

Section 203 of the Clean Air Act prohibits any person to remove or render inoperative any device specifically installed on the vehicle to ensure that the vehicle complies with Emission Control Standards. It is essential therefore that components to the correct specification are fitted and specified engine settings are strictly adhered to.

# Emergency Operating Procedures

Emergency Starting	34
Jump Starting with Auxiliary (Booster) Battery	34
Push Starting	35
Towing	35
Freeing Car from Sand, Mud, Snow or Ice	35
Lifting Jack and Wheel Changing Instructions	36
Jacking	36

## EMERGENCY STARTING

### Jump Starting with an Auxiliary (Booster) Battery

Jump starting can be dangerous if done incorrectly. Therefore, if the following conditions cannot be met, or if you are uncertain about them, we strongly recommend that you leave the starting to a competent technician or towing service.

#### Important Notice:

The following CAUTIONS should be strictly observed when charging, jump starting and while working in or near the battery compartment (behind the passenger's seat) or in the engine compartment.

**CAUTION:** Keep batteries out of reach of children. Batteries contain SULPHURIC ACID. Avoid contact with skin, eyes, clothing or ar. If spilled, flush any contacted surfaces with water immediately and thoroughly, and then get immediate medical attention.

**CAUTION:** THE MAJOR SAFETY PRECAUTION IS TO MAKE THE FINAL STATIONARY METALLIC OBJECT) ON THE ENGINE AT SOME DISTANCE FROM THE BATTERY. THIS HELPS REDUCE THE CHANCE OF AN EXPLOSION DUE TO SPARKS.

**CAUTION:** Hydrogen gas, a by-product produced during normal battery operation, can explode if a flame or spark is brought near the battery.

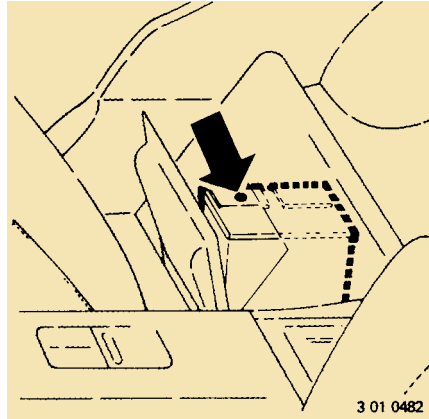

**CAUTION:** DO NOT ATTEMPT TO JUMP START DISABLED VEHICLE IF GASOLINE VAPORS ARE DETECTED IN ENGINE COMPARTMENT.

**CAUTION:** To lessen the risk of injury in case of explosion WEAR EYE PROTECTION OR SHIELD YOUR EYES when working near any battery. Do not lean over a battery.

**CAUTION:** To lessen the risk of a short circuit and/or spark, remove rings, metal watchbands and other metal jewelry. Also, do not allow metal tools to contact at the same time the positive battery terminal (or any metal connected to this terminal) and any

other metal on the vehicle. When attaching the jumper cable clamps to the positive terminals of the batteries, make certain that neither clamp contacts any other metal.

**CAUTION – Fig. 1** Do not try to jump start the vehicle or charge or test the Delco maintenance free battery, if the centre of the test indicator in the battery is bright or light yellow Fig. 1. Instead, install a new battery.

**To Jump Start – Follow these steps carefully:**

**CAUTION:** The following jump starting procedure not only eases access to the necessary connections, it also reduce the possibility of accidental spark or explosion. However, these steps **MUST** be followed carefully.

**CAUTION:** If gasoline fumes are detected within the engine compartment, the engine compartment area must be allowed to ventilate prior to making the necessary connections.

1. This vehicle has a 12-Volt battery and a negative ground electrical system. Make sure the other vehicle or auxiliary battery has a 12-Volt rating.
2. Position the vehicle with the good (Charged) battery so the jump starting cables will reach the engine compartment and prescribed ground of the vehicle to be jump started. Do not let the vehicles touch.

3. Turn off all unnecessary electrically operated accessories in both vehicles with the exception of those lights needed to protect the vehicle and light the work area.
4. Turn off the ignition in the vehicle with the discharged battery. Apply the parking brake firmly and put the automatic transmission in 'P' (manual transmission in Neutral).
5. Raise the engine compartment cover.
6. Connect one end of RED jumper cable to the positive cable terminal + which is fastened to the right side of the engine compartment, and the other end of this cable to the positive terminal of the booster battery *Fig. 2*.
7. Connect one end of the BLACK jumper cable to the negative terminal - of the good battery and the other end to an engine ground location being started (NOT TO NEGATIVE (-) TERMINAL OF BATTERY) taking care that clamps from one cable do not accidentally touch the clamps on the other cable *Fig 2*. Connections must be clean and secure. Cables and connections must also be clear of any moving components (pulleys, belts, etc.).
8. Increase the engine speed in the vehicle with the good battery and let it run for a few minutes. Then start the engine in the vehicle with the discharged battery.

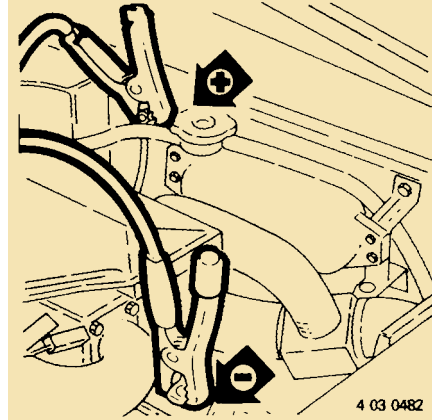

9. Carefully disconnect the cables, reversing the order of the procedure, beginning with the negative cable attached to the vehicle with the discharged battery.

### Push Starting

To avoid damage to your vehicle DO NOT attempt to start the engine by pushing with another vehicle.

### Towing

If towing of your vehicle should be required, please observe the following recommendations to reduce the possibility of vehicle damage.

Towing should be carried out using a FLAT BED towing vehicle.

### Freeing Car from Sand, Mud, Snow or Ice

If your car gets stuck in the sand, mud or snow or ice, move the shift lever on automatic transmission models from 'D' to 'R' in a repeat pattern. (On manual transmission models, move the shift lever from First or Second to Reverse). Apply light pressure to the accelerator pedal while the transmission is in the 'D' or 'R' range (First, Second or Reverse with a manual transmission). Remove your foot from the accelerator while shifting. Do not race the engine. For the best traction, avoid spinning the wheels. Incorrect rocking of your car while it is stuck may result in damage to car components.

**CAUTION: DO NOT SPIN THE WHEELS FASTER THAN 2500 RPM LONGER THAN 30 SECONDS. PERSONAL INJURY AND DAMAGE (INCLUDING TYRE, TRANSMISSION AND/OR REAR AXLE FAILURE) MAY RESULT FROM EXCESSIVE WHEEL SPINNING.**

If the car remains stuck after several rocking attempts, seek other assistance. See also the Notice under 'Automatic Transmissions' in the 'Steering Column Controls' section.

### Lifting Jack and Wheel Changing

The jack is located in the front wall of the front luggage compartment. Access is obtained by turning the two fasteners a quarter of a turn counter clockwise and lifting out the panel complete with jack. Unhook the two remaining straps and remove the jack

# Emergency Operating Procedures



and handle in their bag from the lid. When restowing, ensure the rubber straps are firmly fixed and the fasteners located securely.

**CAUTION:** To reduce the chance of personal injury:

1. Follow all jacking and stowage instructions.
2. Use this jack only for lifting the car during wheel changing.
3. Never get beneath the car when it is supported by this jack.
4. Do not start or run the engine while the car is supported by this jack.

## Instructions

- Park on a firm level surface and apply the parking brake firmly. Set automatic transmission in 'P' (manual transmission in Reverse). Turn on the hazard flasher.
- Take the spare wheel, jack and jack handle/wheel nut wrench from luggage compartment.
- Loosen, but do not remove, the wheel nuts by turning the wrench counter clockwise. Notice: Capped chrome wheel nuts can be damaged if the wrench is not fully seated on the wheel nuts.

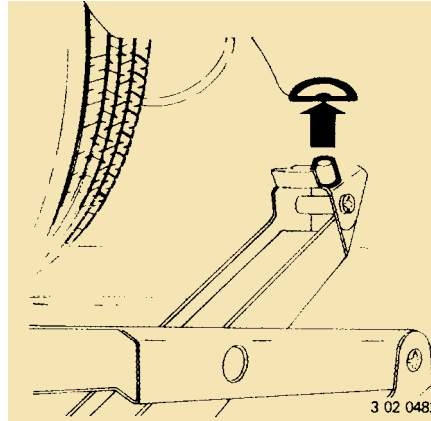

Jacking – Fig. 3

- Place jack securely in proper location.
- Before using the jack, block both the front and rear of the wheel on the same side as the wheel being removed.
- Operate the jack with a slow, smooth motion. Raise the car so the inflated spare tyre will just clear the surface.
- Remove the wheel nuts and wheel.
- Install the spare wheel and replace the wheel nuts. Then, slightly tighten each nut. The wheel must be seated squarely on the hub.
- Lower the car and fully tighten all wheel nuts by applying clockwise pressure near the end of the wrench.

**CAUTION:** AS SOON AS POSSIBLE AFTER INSTALLING A WHEEL – AND AT THE INTERVALS SHOWN ON THE CHART IN THE MAINTENANCE SCHEDULE FOLDER – HAVE A MECHANIC TIGHTEN THE WHEEL NUTS WITH A TORQUE WRENCH TO 100 NIM (70lb ft). WHEEL NUTS SHOULD BE TIGHTENED ALTERNATELY AND EVENLY TO THE CORRECT TORQUE.

**CAUTION:** NEVER USE OIL OR GREASE ON THE STUDS OR NUTS. IMPROPERLY TIGHTENED WHEEL NUTS COULD EVENTUALLY ALLOW THE WHEEL TO COME OFF WHILE THE CAR IS MOVING, CAUSING LOSS OF CONTROL.

Replace the jack and wheel in the luggage compartment and tighten them securely to avoid rattles.

When possible, check the pressure in the tyre you just put on. The correct tyre pressure is shown on the Tyre Placard on the glove box door.

**CAUTION:** DO NOT DRIVE AT CONTINUOUS SPEEDS OVER 50 MPH (80 km/h) WHEN COMPACT SPARE TYRE IS INSTALLED.

# General Information

Technical Data	38
Engine	38
Cooling System	38
Electrical System: 12 Volt	
Negative Ground	38
Transmission	38
Final Drive – Manual and Automatic	38
Steering	38
Brakes	38
Suspension	38
Geometry	38
Capacities	39
Dimensions	39
General	40
Tyre Pressures	40
Fuel Requirements	40
Emission Control System Laws	40
Registration in Foreign Countries	40
Owner Assistance	40

## TECHNICAL DATA

### Engine

Rear mounted, liquid cooled, light alloy 90° V6, with single overhead camshaft per bank and cross flow cylinder heads. Fuel delivery is accomplished with a C.I.S. (Continuous Injection System) mechanical fuel injection, Bosch K-Jetronic.

Cylinder bore	91 mm (3.58 in)
Stroke	73 mm (2.87 in)
Displacement	2849 cc (174 cu in)
Power rating	130 SAE NET HP @ 5,500 RPM
Maximum Torque	208 Nm (153 ft lb) @ 2,750 RPM
Compression Ratio	8.8:1

Note: For tune-up specifications see label under engine compartment lid.

### Cooling System

Positive pressure, closed system containing a 50% water, 50% (Borax free) Ethylene Glycol coolant mixture. Engine heat is dissipated through a forward mounted radiator equipped with twin thermostatically controlled electric fans.

### Electrical System: 12 Volt Negative Ground

Battery	Delco Remy Freedom
Capacity	75 Amp/hour
Spark Plugs	Bosch HR 6 DS (Platinum Tipped)
Spark Plug Gap	0.6 – 0.7 mm (0.024 – 0.028 in)
Spark Plug Torque	17.20 Nm (13 – 15 ft lbs)

### Transmission

Gear Ratios	
Manual – 5 speed	
1st : 3.364	4th : 1.057
2nd : 2.059	5th : 0.8205
3rd : 1.381	Rev : 3.1818
Automatic – 3 Speed	
1st : 2.40	3rd : 1.00
2nd : 1.48	Rev : 1.92

### Final Drive – Manual and Automatic

Transaxle with double universal half shafts  
Reduction Ratio – 3.44 : 1

### Steering

Rack and pinion, manually operated	
Wheels turns, lock to lock	2.4 turns
Turning circle	12.80 m (42.0 ft)

### Brakes

Service brakes.

Power assisted discs front and rear

Parking brake.

Mechanical, self-adjusting, acting on rear discs.

### Suspension

Front

Unequal length upper wishbone and lower link, coil springs with telescopic shock absorbers and stabilizer bar.

Rear

Diagonal trailing radius arms with upper and lower links, coil springs with telescopic shock absorbers.

### Geometry

Front

Toe-in 3 mm (0.12 in) per wheel

Caster Angle 3 ½° to 4° positive

Camber Angle 0° to 1.4° negative (non-adjustable)

King Pin Inclination 8° + 1/2° - 0° (non-adjustable)

Rear

Toe-in 3 mm (0.12 in) per wheel

Camber 1/4° to 3/4° negative (non-adjustable)

## Capacities

Unit	Metric Measures	U.S. Measures
*Engine Crankcase Drain and refill (when changing filter add 1/2 pt.)	6.5 litres	6.8 quarts
Cooling System	11.0 litres	2.9 gallons
*Manual transmission	3.7 litres	7.75 pints
*Final drive (automatic transmission only)	1.5 litres	3.6 pints
Fuel Tank (91 octane unleaded only)	51.6 litres	13.2 gallons
A/C Refrigerant	1125 grams	2.5 lbs

\* SEE RECOMMENDED LUBRICANTS CHART

## Dimensions

	Inches	Millimetres
Length (overall)	166.0	4213
Wheelbase	95.0	2410
Width (overall)	73.1	1856
Width (over doors)	72.83	1850
Height (doors closed)	44.88	1140
Height (doors open – over mirror)	77.2	1960
Track – front	62.6	1590
Track – rear	62.5	1588
Ground clearance – front	5.6	142
Ground clearance – rear	6.1	155



## General

Curb weight with full fuel tank	2844 lbs (1290 kg)
Luggage capacity	14 cu ft – 0.3964 cu metres
Ramp angle	22° front 27° rear
Approach angle	14°
Approx. Weight Distribution	38% – front 62% – rear

## Tyre Pressures

Spare	60 lbf/in2	4.2Kgf/cm2	4.1 bars
Normal Driving – Front	23 lbf/in2	1.6 Kgf/cm2	1.5 bars
	Rear	30 lbf/in2	2.1 Kgf/cm2
Continuous High Speed Driving – Front	29 lbf/in2	2.0 Kgf/cm2	2.0 bars
	Rear	34lbf/in2	2.3 Kgf/cm2

## Fuel Requirements

U.S.A.

Your De Lorean is designed to operate at factory specifications at UNLEADED GASOLINE only of at least 87 anti-knock index (R+M/2) (91 research octane number).

Other Territories

## Emission Control System Laws

Any modification of the emission control system prior to the first sale and registration of a new vehicle in the United States is subject to penalties under Federal Law. Any such modifications made thereafter may also be subject to penalties in some states.

## Registration in Foreign Countries

If you plan to register your De Lorean in another country, first make sure that it meets that country's regulations (e.g. safety standards, emission control standards). We advise you to contact the local De Lorean Distributor, or De Lorean Motor Cars (1982) Ltd., if you have any questions.

## Other Assistance

It is the concern of DMC and its dealers that you receive complete satisfaction with regard to your DMC product.

In the event you have any questions relating to your De Lorean vehicle, we recommend you refer these to your local DMC dealer who will make whatever enquiries necessary on your behalf.

